

# 4 CH MIXER

## USER'S MANUAL (ENGLISH VERSION)

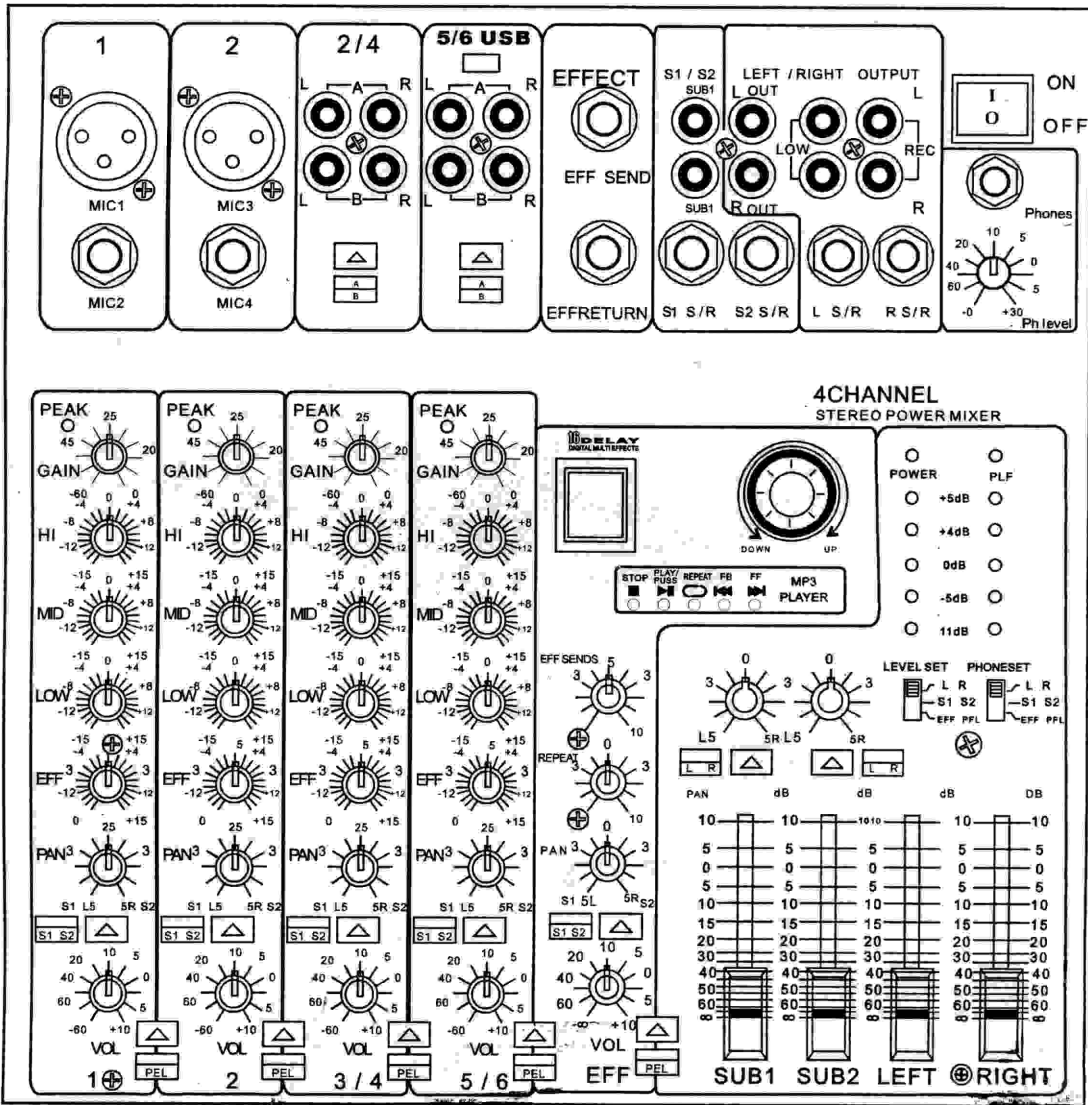

Please keep this manual for future reference



## Safety Warning

To use this appliance in a better way, please carefully read the user's manual and observe the safety warning rules.

## Warning

This appliance can only use the power voltage of 220V-/50Hz +/-10%.

Do not spill water, oil or other liquid into the appliance.

Keep away gasoline, alcohol, or other flammable or explosive or volatile liquid from the appliance.

Do not place small metal or sundries on the surface of the appliance.

Do not scratch, twist, bundle, drag or heat the power cord. Damaged power cord should be replaced by the qualified maintenance personnel.

Do not press hard or hit strongly the appliance and avoid working under the environments of thunder, moisture, dust, or the shining sun.

Do not use wet hand to pull, detach or install the power cord.

If you find any phenomenon like smoke, smell, noise, fall-down or any leak-in of liquid, do not use the appliance, and send it to the qualified maintenance personnel to clean or repair.

If you are not the qualified maintenance personnel, do not open the appliance to maintain it. Do not transform the appliance.

If you do not observe the above warning, it may cause the risks of electric shock, damage or fire.

## Cautions

1. Please ensure that you keep the appliance far away from the following environments:

Dangerous flammable or explosive items.

Moisture enhancer, steam, oil splash, moisture or covered dust.

Overheated environments like sealed places, near stove, or under direct sunshine,

Water drop or oil drop environment.

2. The appliance emits heat when working. Do not touch this appliance by hand at will. There are force wind cooling window at the back and ventilation windows at sides to prevent overheat. Do not block them and ensure a good ventilation system.

3. Before moving the appliance, please shut off the power, pull out the power plug and detach the connecting cord.

4. Before connecting this appliance, please turn off the power switch.

5. Before connecting the socket of the appliance, the plug should be rubbed clean to make sure of good contact.

6. Use special cable of loudspeaker and ensure its firm connection when the appliance is connected to the loudspeaker.

7. Do not use wet hand to touch the power plug. Keep body balanced to ensure safe connection.

8. Before connecting power supply, adjust the volume knob to minimum and choose a proper working mode.

9. Regularly clean this appliance. Please turn off the power and pull out the power cord before cleaning. Use soft cloth. pile-up dust inside the appliance will cause deficiency. (Cleaning this appliance can help for its stable usage. Please send it to the qualified maintenance personnel when inside cleaning is required. Volatile solutions like toluene and alcohol cannot be used to clean this appliance. You should choose a specialized cleanser.)

10. Please pull off the power plug if not use for a long period of time.

## Contents

|               |                      |          |   |
|---------------|----------------------|----------|---|
| 2, 3 -----    | Control Panel        | 8 -----  | Regular Parameters                            |
| 4, 5, 6 ----- | Input & Output Panel | 9 -----  | Circuit Map                                   |
| 6 -----       | Rear Panel           | 10 ----- | Connection to Input & Output/<br>Installation |
| 7 -----       | Notice               | 11 ----- | Basic Operation                               |
| 7 -----       | Input Parameters     | 12 ----- | Practical Application                         |
| 7 -----       | Output Parameters    | 13 ----- | Word Pad                                      |



# Names Of Panel Parts & Amplification

## CONTROL PANEL

### 1. PEAK

Signal peak indicator, indicating the signal level. When it blinks occasionally, the appliance is in its best input shape. If it keeps b-right, it indicates overload signal and distortion.

### 2. GAIN

Gain control. When you adjust this knob, you can perform a boost or attenuation to the channel level from 60 dB to 0 dB.

### 3. HI, MID, LOW

Channel equalization adjustment. HI is high frequency band. MID is middle frequency band. LOW is low frequency band. When the knob is at "0", the response is flat. Clockwise is strengthening. Counter-clockwise is attenuating.

### 4. EFF

Channel effects volume control. By adjusting this knob, you can allow the channel signal to enter into the effector inside the appliance, and adjust the effects volume.

### 5. PAN

Balanced positioning control. By adjusting this knob, you can distribute the audio signals of this channel evenly to the left and right audio channels, and make it reach an ideal working condition.

### 6. S1 S2

SUB1, SUB2 subgroup select button. This button is to select the output of SUB1 or SUB2. The output does not go through the amplifier.

### 7. VOL

Channel volume controller. Push upward to increase, and push downward to decrease until zero.

### 8. PFL

Channel pre-set monitor switch. When pressed down, you can monitor the sound quality of this channel through headphone.

### 9. BAL

Main sound left and right balance. Only use in the stereo channel.

### 10. DISPLAY digital display

Effectors' type select display. There are 16 types of 0-9 and A-F, representing the delay time of the effectors. When start, it is set to be "7" the normal use type. If needed, it can be adjusted to the effects of an ideal sound field.

### 11. EFF SEND

Effect signal send volume. It can control the fixed volume of transmitted effect signals from every channel to the master effect line of this appliance.

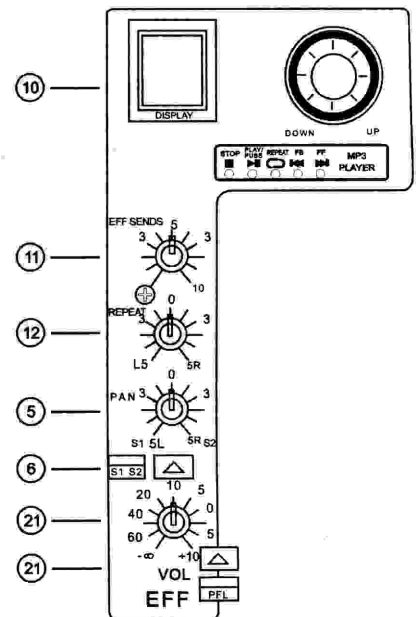
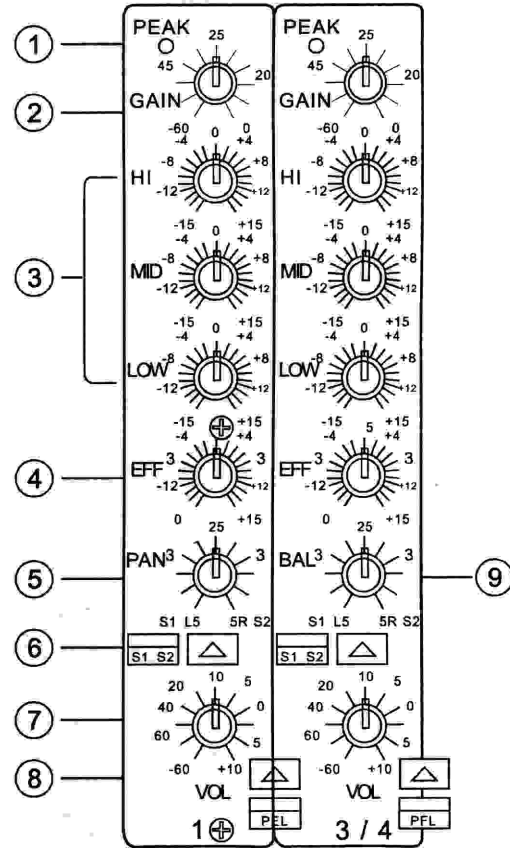

# CONTROL PANEL

## 12. REPEAT

Effect repeat times adjustment.

## 13. DOWN UP

Effector type select dial shown in 10. Turn clockwise, there are 0-9, A-F totally 16 types. In normal turn-on condition, it shows type "7".

## 14. SUB1

Subgroup SUB1 LINE output volume control. This output does not go through the amplifier of this appliance. It can be set up by 18, displayed by 23 and sent out by 34.

## 15. SUB2

Subgroup SUB2 LINE output volume control. This output does not go through the amplifier of this appliance. It can be set up by 18, displayed by 20 and sent out by 34.

## 16. LEFT

Main sound channel left side signal output volume control. It is set up by 18, displayed by 20, and send out LINE signals through 37, or send out to speaker through 46.

## 17. RIGHT

Main sound channel right side signal output volume control. It is set up by 18, displayed by 20, and send out LINE signals through 37, or send out to speaker through 45.

## 18. LEVEL SET

Level display select. You can tune it to select correspondently L/R signal, S1/S2 signal, or EFF effect signal displayed by 23 and 20.

## 19. PHONE SET

Tune to select headphone monitor. You can select headphone monitor by 41.

## 20. LED Level Display

It can display R, SUB2 and PFL signals.

## 21. PFL Monitor Working Indicator.

## 22. Power Indicator.

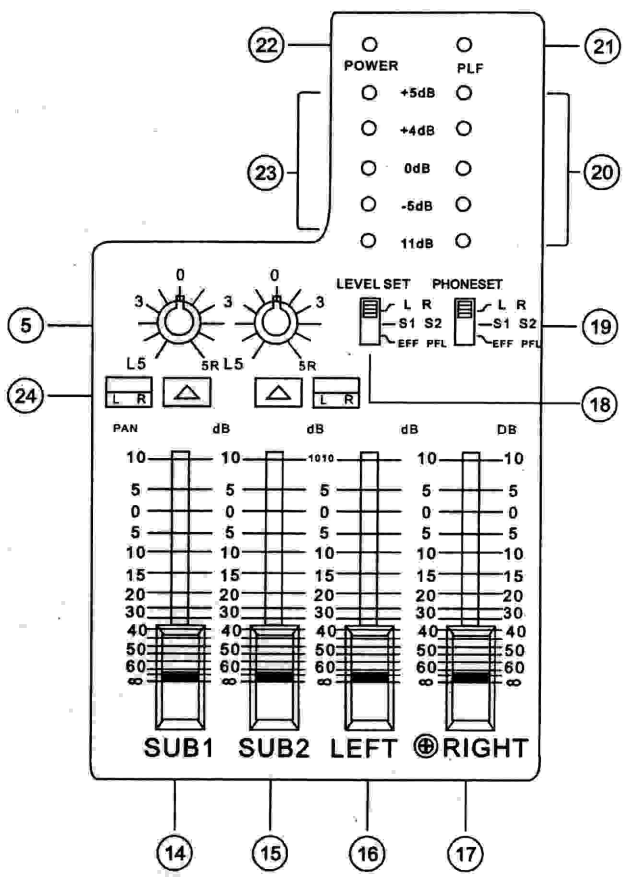



# INPUT AND OUTPUT PANEL

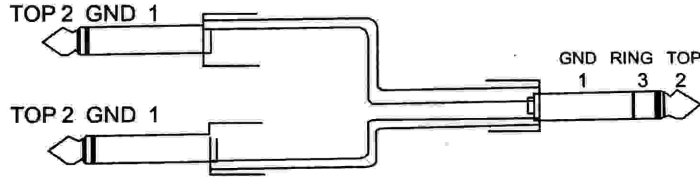
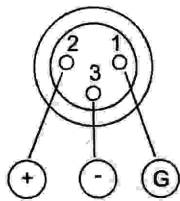
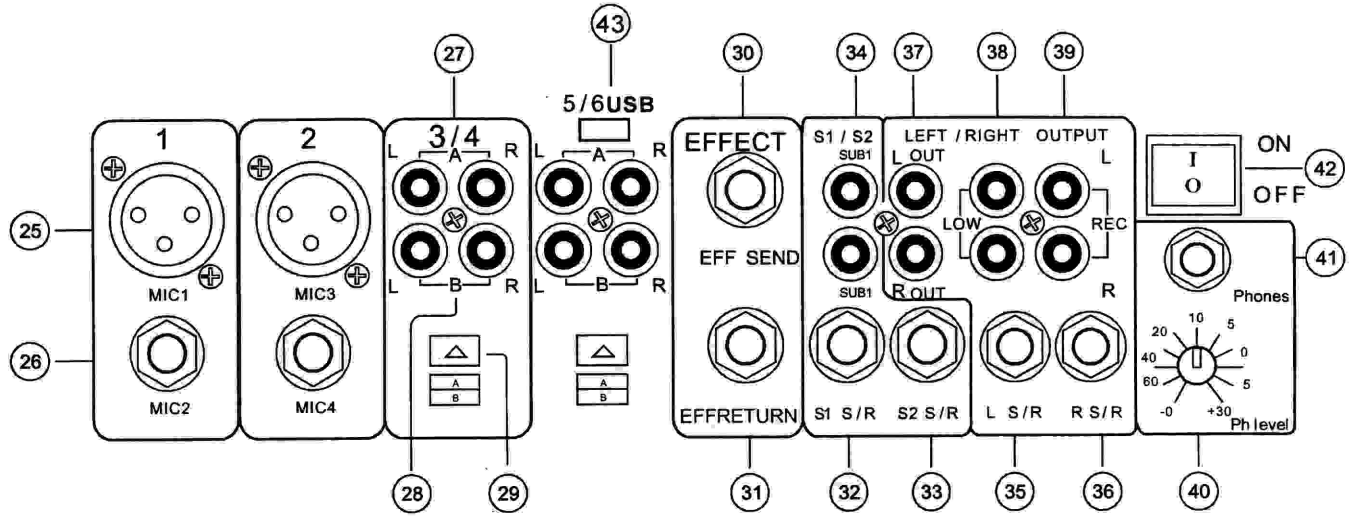

### 23. LED Level Display

It can display L, SUB1 and EFF signals.

### 24. L, R Control

This button is the switch controlling SUB signal input into the STEREO master line. When pressed down, corresponding SUB signal input into corresponding PAN control balance.

### 25. MIC Input

This is an XLR balance connection. 1 is ground. 2 (+) is in-phase input. 3 (-) is out-of-phase input, It can be used with 26 simultaneously.

### 26. MIC Input Jack

This is an LX unbalance connection. 1 is ground. 2 is in-phase input.

### 27. Route A (L, R) Input Jack

This connection is stereo route A. L and R input jack is controlled by the switch of 29.

### 28. Route B (L, R) Input

This connection is stereo route B. L and R input jack is controlled by the switch of 29.



## INPUT AND OUTPUT PANEL

### 29.A、 B Input Select

This button is to select A or B. Press-down is B input. Otherwise it is A input.

### 30. EFF SEND Effect Signal Send Jack

This jack is XL type. When there is an external audio processor, this is the effect signal output jack and switch to built-in digital effector.

### 31.EFF RETURN Effect Signal Input Return Jack

This is the signal input jack when there is an external audio processor. It switches to built-in digital effector. 12 will not function.

### 32.S1 S/R (SEND/RETURN) Send/Return Jack

This jack is XLR type. It is the signal input and output when S1 connects external audio processor.

### 33. S2 S/R (SEND/RETURN) Send/Return Jack

This jack is XLR type. It is the signal input and output when S2 connects external audio processor.

### 34.S1/S2 (SUB1, SUB2) Output Jack

SUB1 is the output jack of Subgroup 1 signal master line after mixing. SUB2 is the output jack of Subgroup 2 signal master line after mixing.

### 35.L (S/R) Left Channel Signal Send/Return Jack

This jack is XLR type. It is the signal send and return jack when the left channel connects external audio processor.

### 36.R (S/R) Right Channel Signal Send/Return Jack

This jack is XLR type. It is the signal send and return jack when the right channel connects external audio processor.

### 37. L out R out Main Sound Channel Left and Right Output

L out is the output jack of signal from the STEREO master line L (left) channel after mixing. R out is the output jack of signal from the STEREO master line R (right) channel after mixing.

### 38.LOW Sub-bass Output Jack

This is the output jack of L and R signals mixed from the STEREO master line after processed by the built-in bass digital frequency divider.

### 39.REC (L, R) Record Output

This is the output jack of left and right channel signals from the STEREO master line after mixing. It is not controlled by LR main fader but by the volume controller of each channel.

### 40.PH LEVEL Headphone Level Controller

This controller is to adjust the headphone monitor output volume controlled by 19 monitor set select.



## Names Of Panel Parts & Amplification

### INPUT AND OUTPUT PANEL

#### 41. PHONES Headphone Output Jack

This is a monitor headphone jack of XLR type. It is controlled by 19 select with the volume adjusted by 40.

#### 42. ON/OFF Power Switch

This is the external power supply switch. When turned on, power indicator 22 illuminates, and the appliance is working. When turned off, power indicator turn dark.

#### 43. USB

HOST(USB2.0) Function (MAX 500 MA)

used for U disk, MP3, hard Disc & flash disc reader, etc.

### REAR PANEL

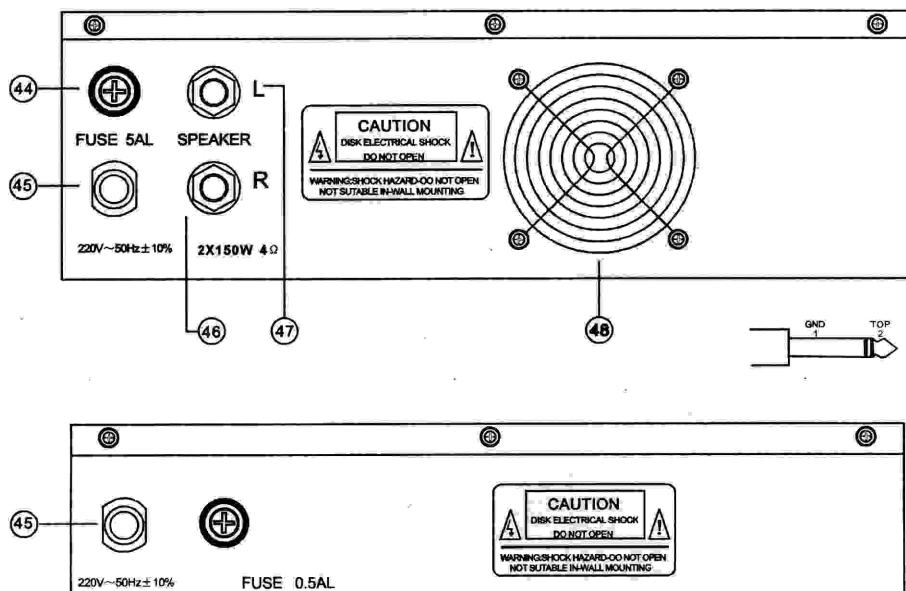

#### 44. Fuse 5AL

This is the fuse of external power supply of the appliance. 5 Amp for PMX Model. 0.5 Amp for MX Model.

#### 45. 220V-50Hz +/- 10% (Service Voltage & Frequency) Power Cord

#### 46. SPEAKER R-Channel Speaker Jack

This is a XL type jack to connect right-channel speaker with output impedance of 0.1 Ohm and rating load impedance of 4-8 Ohm.

#### 47. SPEAKER L-Channel Speaker

This is a XL type jack to connect left-channel speaker with output impedance of 0.1 Ohm and rating load impedance of 4-8 Ohm.



**NOTICE:**

1. When turning on/off the appliance, you must put the main fader volume control to its minimum position.
2. Use qualified power supply cable and power plug. Ensure a good connection of the power cord of the appliance to the power supply plug. When not used, the power supply must be disconnected to avoid accidents.

**INPUT PARAMETERS**

| INPUT INSERT     | GAIN       | INPUT IMPEDANCE | RATING IMPEDANCE       | INPUT LEVEL    |                      | CONNECTION TYPE      |
|------------------|------------|-----------------|------------------------|----------------|----------------------|----------------------|
|                  | ADJUSTMENT |                 |                        | SENSITIVITY    | MAX. UNLIMITED LEVEL |                      |
| MIC INPUT        | MAX        | 5K $\Omega$     | 50~600 $\Omega$<br>MIC | -60dB (775uV)  | -40dB (7.75mV)       | XLR-3-1              |
|                  | MIN        |                 |                        | -16dB (123mV)  | +4dB (1.23V)         |                      |
| MIC INPUT        | MAX        | 50K $\Omega$    | 50~600 $\Omega$<br>MIC | -60dB (775uV)  | -40dB (7.75mV)       | HEADPHONE JACK (TRS) |
|                  | MIN        |                 |                        | -16dB (123mV)  | +4dB (1.23V)         |                      |
| LINE INPUT       | MAX        | 10K $\Omega$    | 600 $\Omega$<br>ROUTE  | -34dB (15.5mV) | -14dB (155mV)        | (RCA) PIN JACK       |
|                  | MIN        |                 |                        | +10dB (2.45V)  | +30dB (24.5V)        |                      |
| L/R S INSERT IN  |            | 10K $\Omega$    | 600 $\Omega$<br>ROUTE  | +4dB (1.23V)   | +20dB (7.75V)        | HEADPHONE JACK (TRS) |
| S1/S2 INSERT IN  |            | 10K $\Omega$    | 600 $\Omega$<br>ROUTE  | +4dB (1.23V)   | +20dB (7.75V)        | HEADPHONE JACK (TRS) |
| EFFECT RETURN IN |            | 10K $\Omega$    | 600 $\Omega$<br>ROUTE  | +4dB (1.23V)   | +20dB (7.75V)        | HEADPHONE JACK (TRS) |

1. Input Sensitivity: The availed rating output of the set maximum gain is minimum level.
  2. balance type (T=HOT, R=CILD, S=GND)
  3. unbalance type (T-OUT, R=IN, S=GND)
- \*, 0dB=0.775V, 0dBV=1Vrms

**OUTPUT PARAMETERS**

| OUTPUT CONNECTION | OUTPUT IMPEDANCE | RATING IMPEDANCE         | OUTPUT LEVEL        |                      | CONNECTION TYPE |
|-------------------|------------------|--------------------------|---------------------|----------------------|-----------------|
|                   |                  |                          | RATING OUTPUT LEVEL | MAX. UNLIMITED LEVEL |                 |
| LEFT RIGHT OUT    | 150 $\Omega$     | 600 $\Omega$<br>ROUTE    | +4dB (1.23V)        | +20dB (7.75V)        | (RCA) PIN JACK  |
| SUB1 SUB2 OUT     | 150 $\Omega$     | 600 $\Omega$<br>ROUTE    | +4dB (1.23V)        | +20dB (7.75V)        | (RCA) PIN JACK  |
| LEFT RIGHT SEND   | 150 $\Omega$     | 600 $\Omega$<br>ROUTE    | +4dB (1.23V)        | +20dB (7.75V)        | HEADPHONE JACK  |
| SUB1 SUB2 SEND    | 150 $\Omega$     | 600 $\Omega$<br>ROUTE    | +4dB (1.23V)        | +20dB (7.75V)        | HEADPHONE JACK  |
| EFFECT SEND       | 150 $\Omega$     | 600 $\Omega$<br>ROUTE    | +4dB (1.23V)        | +20dB (7.75V)        | HEADPHONE JACK  |
| REC OUT(L/R)      | 600 $\Omega$     | 600 $\Omega$<br>ROUTE    | -10dBV (316mV)      | +10dB (3.16V)        | (RCA) PIN JACK  |
| LWO OUT           | 150 $\Omega$     | 600 $\Omega$<br>ROUTE    | +4dB (1.23V)        | +20dB (7.75V)        | (RCA) PIN JACK  |
| PHONES OUT(L/R)   | 100 $\Omega$     | 32 $\Omega$<br>HEADPHONE | 3mW                 | 100mW                | HEADPHONE JACK  |
| SPEASER OUT(L/R)  | 0.1 $\Omega$     | 4/16 $\Omega$<br>SPEAKER | 180W/4 $\Omega$     | 180W/4 $\Omega$      | HEADPHONE JACK  |

1. Impedance unbalance type (T=OUT, R=1N, S=GND)
2. Impedance unbalance type (T=L, R=R, S=GND) ,0dB=0.775V, 0dBV=1Vrms





## TECHNICAL SPECIFICATIONS

### REGULAR PARAMETERS

|                                 |   |   |
|---------------------------------|---|---|
| FREQUENCY RESPONSE              | 20Hz-20 KHz+1dB, -3dB<br>@1W Output 8Ω (SPEAK OUT)  | Overall Channel Control:<br>Min. Level  |
|                                 | 20Hz-20 KHz+1dB, -3dB<br>@+4dB Output to 600 (ST OUT,<br>MONO OUT, EFFECT SEND,<br>SUB OUT)   | Overall Channel Control:<br>Min. Level  |
| MAX. OUTPUT LEVEL               | STEREO: When 1KHz 150Wx2/8 @ 0.5% THD<br>When 1KHz 180Wx2/4 @ 0.5% THD<br>Less than 128dB Input: -63dB remnant noise (SPEAKER OUT)  |   |
| NOISE                           | -95dB remnant noise (ST OUT, EFFECT OUT, SUB OUT)   |   |
|                                 | -87dB   | ST/SUB Main Control: Max Level<br>Overall Channel Controller: Min. Level                      |
|                                 | -64dB   | ST/SUB Main Control: 1 Channel<br>Controller: Max Level<br>1 Channel Gain Control: Max. Level |
|                                 | -80dB   | Main Channel Gain Control: Max<br>Level<br>Overall Channel Level Controller:<br>Min. Level    |
| T.H.D.                          | When <0.5% @ 20Hz-20KHz, 120W Output to 4Ω (SPEAK OUT)<br>When <0.3% @ 20Hz-20KHz, +14 dB Output to 600Ω<br>(ST OUT, SUB OUT, EFFECT OUT)   |   |
| MAX VOLTAGE GAIN                | 91 dB MIC IN to SPEAKER OUT (Single Route Mic)<br>64 dB MIC IN to ST, OUT, SUB OUT (Single Route Mic)<br>46 dB ST IN to ST OUT SUB OUT (Double Audio Routes)<br>70 dB to EFFECT SEND (Single Route Mic) |   |
| MIC. GAIN CONTROL               | 44dB Tunable  |   |
| POWER AMP. LEVEL CONTROL        | 14dB Tunable  |   |
| LEVEL METER                     | 5 band LED level meter  |   |
| CHANNEL PEAK CHARACTER          | Every channel EQ signal limit 3dB illuminates.  |   |
| INPUT CHANNEL CHARACTER         | HI: 10KHz, MID: 2.5KHz Peak, LOW: 100Hz   |   |
| BUILT-IN DIGITAL EFFECTER       | 16 types, PARAMETER control digital tube instructs.   |   |
| BUILT-IN POWER AMP              | Delay when start. Mid-point DC test and overload protection   |   |
| FAN CIRCUIT                     | DC24V fan, no-grade temperature control speed adjusting.  |   |
| POWER SUPPLY DEMAND/CONSUMPTION | PMX Series: 220V-50Hz/300W<br>MX Series: 220V-50Hz/30W  |   |
| TECHNICAL SPEC/SAFETY SPEC      | In conformity to Q/EJYSO-2002 L0063426-8 standard/China<br>National Compulsory Product Certification: 2003010807719   |   |



CIRCUIT PRINCIPLE BLOCK DIAGRAM

BLACK DIAGRAM

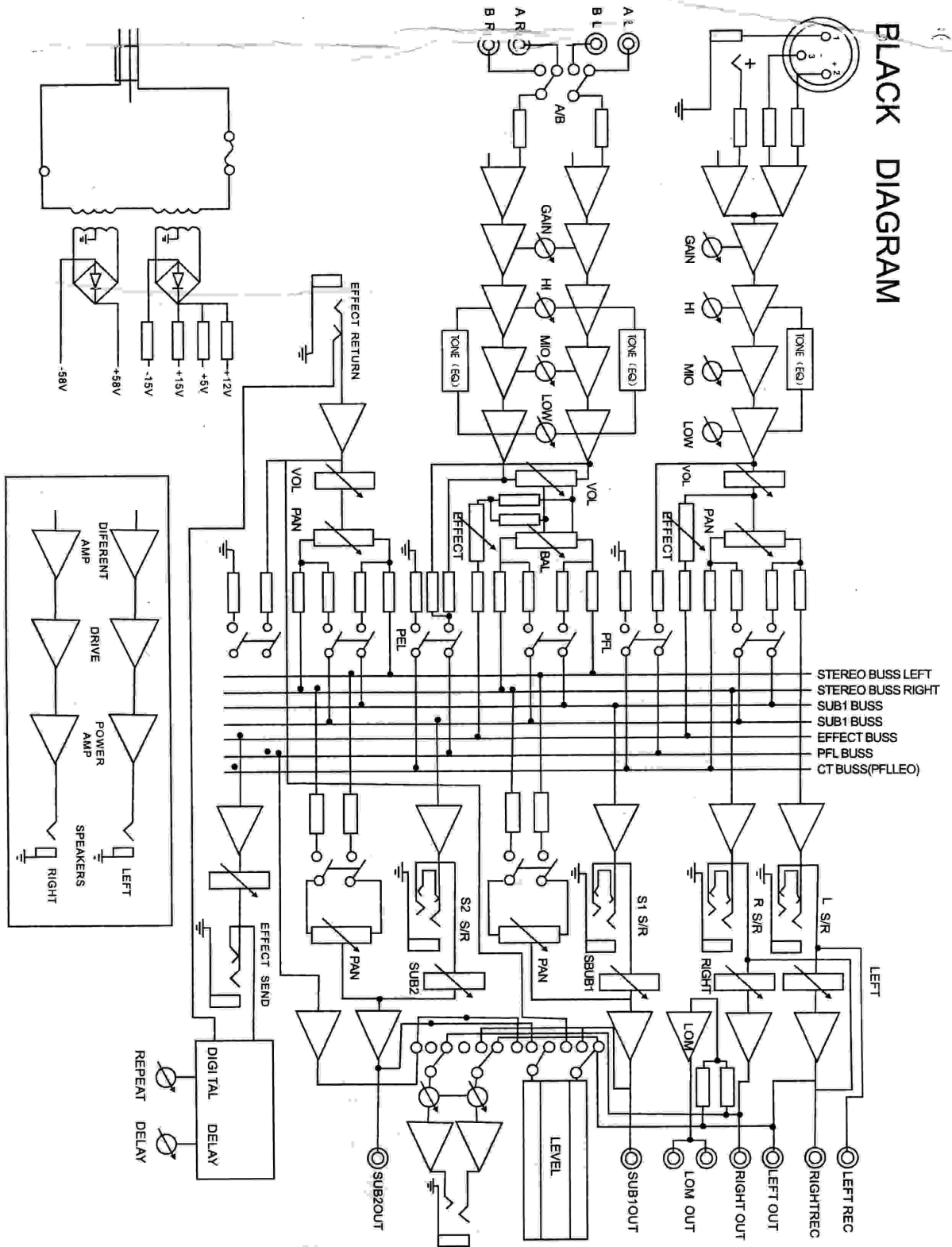



## CONNECTION TO INPUT & OUTPUT/INSTALLATION

Generally connect the speaker to the rear panel. If you need more speakers, make connection to jacks of stereo system, output ST SUB1 SUB2.

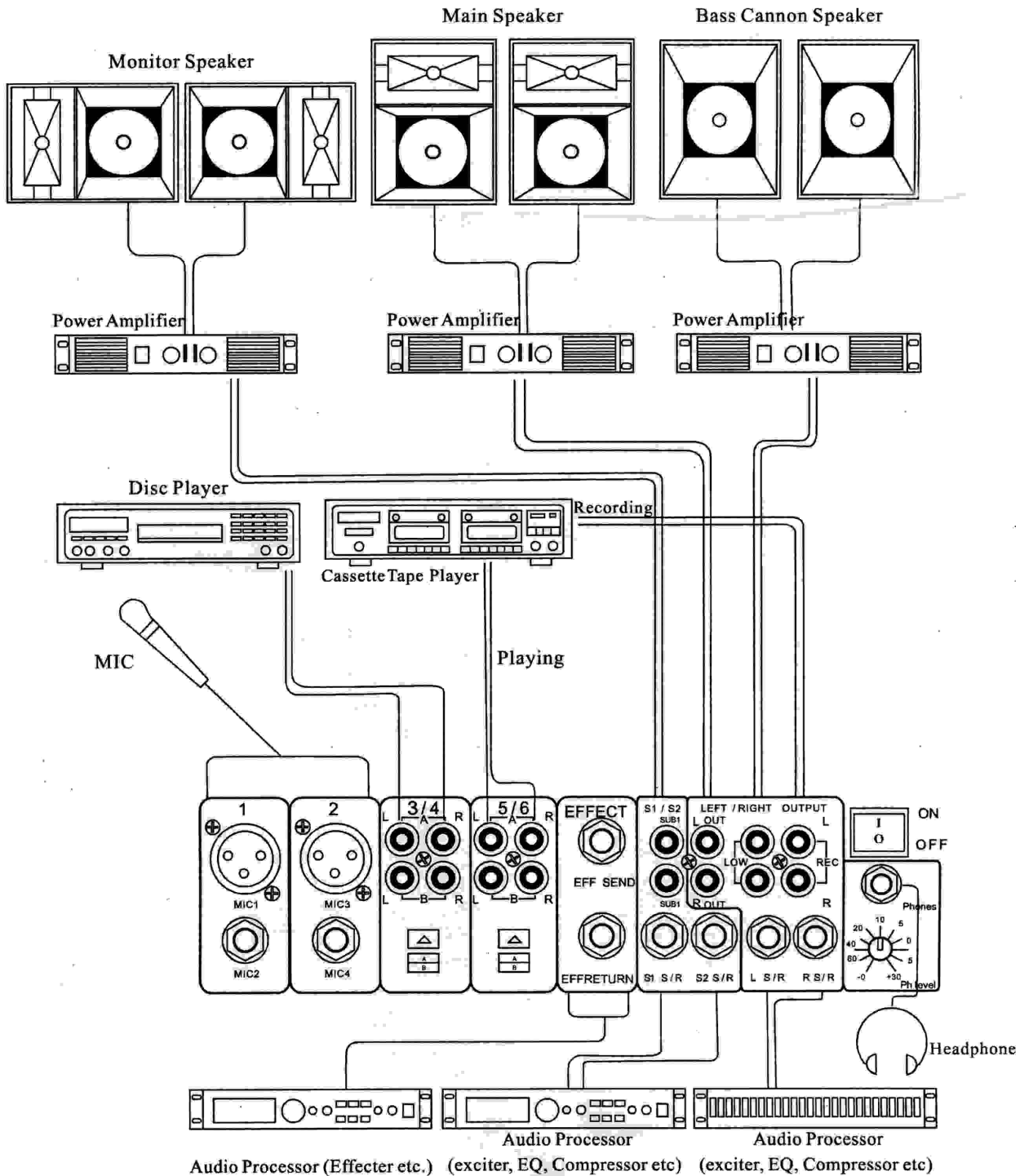



## BASIC OPERATION

### Connecting MIC & Audio Output

1. Before connection, please ensure that the power of the newly installed equipments is at shut-off status, and tune the volume knobs of all channels of the mixer and the main volume fader to the minimum position.
2. Connect the cable to your microphone or other musical instruments. Single-routed channel marked with MIC can use two microphones simultaneously.
3. First turn on the power of the peripheral equipments, second connect the power of the main appliance, and then connect the power of the additional equipments.  
Notice: When turn off, it goes just the opposite direction. First turn off the additional equipment, then the main appliance, and finally the peripheral equipments.
4. You should adjust the Gain control knob to have the PEAK indicator blink when the sound of the microphone or the play of the music reaches its highest volume.
5. To make its sound reach its best dynamic feeling and optimum quality under the condition of boosting LEFT, RIGHT, SUB1, SUB2 controller of the master control to 10 position, you should tune the volume knobs of every channel in use to maximum, and then adjust the GAIN to the position where the PEAK indicator blinks. At this time, howling will not occur from the microphone, and the low quality of sound resulting from wave distortion will not appear in the line input. You can set up the GAIN knob, and adjust the volume controller of relevant channel if increase or decrease is needed.
6. Volume fader adjusts master volume.

### CONNECTING EXTERNAL AUDIO PROCESSORS

1. Connect the microphone and audio signal sources to the required channel, and then adjust the volume and tone.
2. When connecting external effector, you should link the input/output of the effector to the relevant EFF SEND and EFF RETURN, and adjust the volume by the EFF volume controller of relevant channel, and then adjust the sent volume by the EFF SEND signal transmission controller, and adjust the total volume of the effects by master EFF VOL, and adjust balance by the relevant PAN controller, and finally transmitting to STEREO master line and S1, S2 master line.
3. When connecting external equalizer or other processor, you need to make corresponding connections to LEFT, RIGHT or SUB1, SUB2. Use the XLR jacks of LS/R, RS/R or S1S/R, S2S/R and the input/output of the external equipments, and then return to input to the master control of the appliance, output through L out R out or SUB1, SUB2 out. Notice: SUB1 and SUB2 match S1 S2 switches and PAN controller, and then input to STEREO master line.
4. Adding sub-bass equipment  
Link the power amplifier to the LOW output of the mixer, and adjust the volume set.
5. Connecting recording equipment  
Connect the recorder to the REC output jack of the mixer. Recording level is not controlled by the main fader but by the relevant channel sound and external audio treatment.



# PRACTICAL APPLICATION

## APPLICATION OF MIXER AS THE AUDIO EQUIPMENT FOR MEETING ROOM/BANQUET HALL

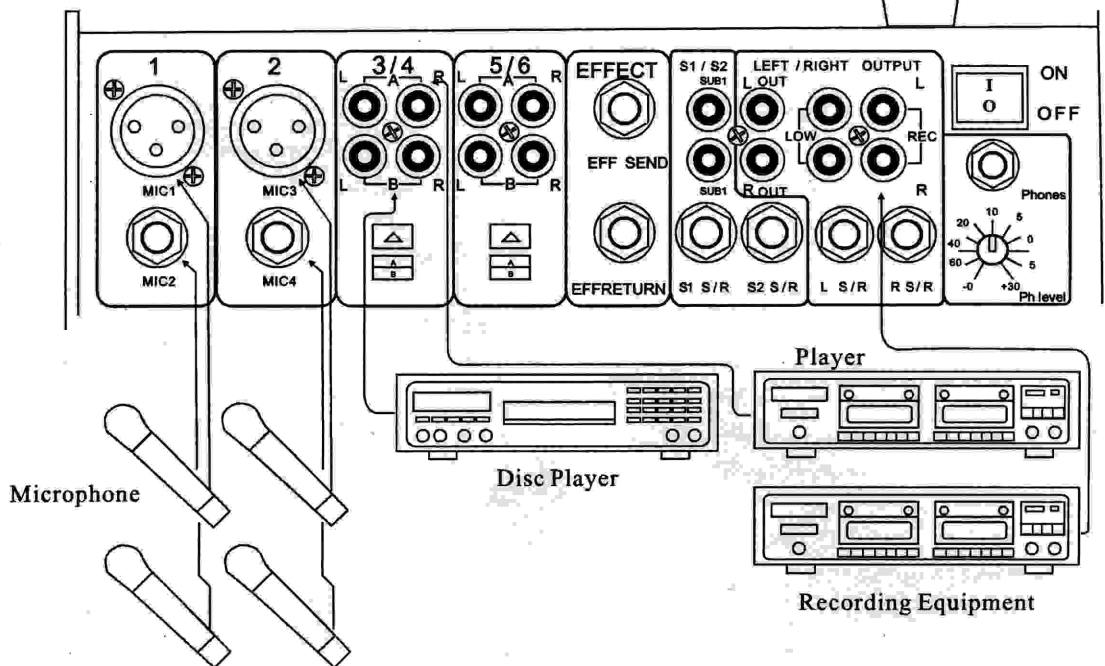
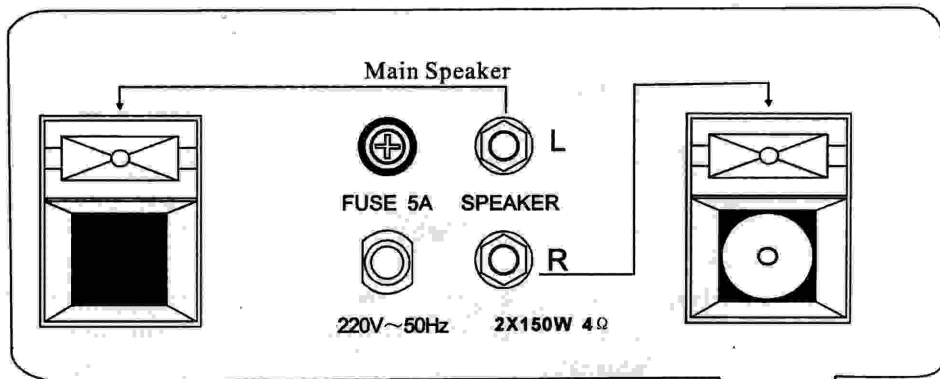

1. Connect the equipments to the mixer and speakers.
2. Operate according to Point 3 to turn on/off the power.
3. When the disc player is on, use the GAIN control of relevant channel to adjust the PEAK indicator until it b-links. Adjust the LEFT and RIGHT control to the position of 10, and then tune the VOL control of relevant channel to proper volume.

