

MH-BEAM MSD700W

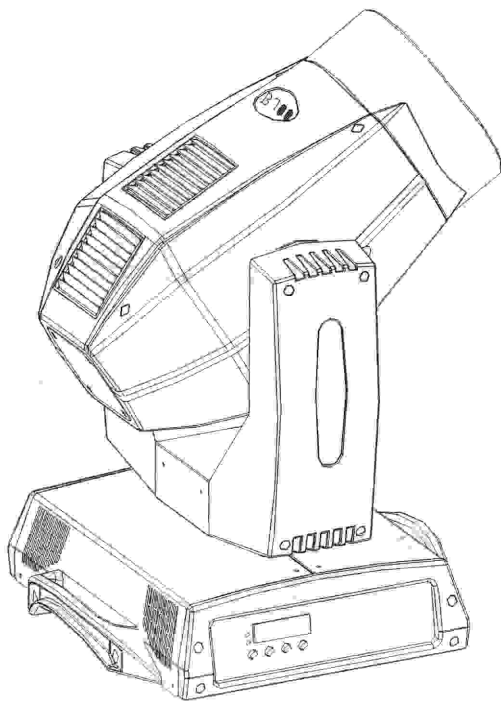

Catalogue

Maintenance

Statement

Safety Precautions

Products Instruction

Menu Function:

Channels Control:

Maintenance

- 1、 To reduce the risk of electrical shock or fire, do not expose this unit to rain or moisture.
- 2、 Do not spill water or other liquids into or on to your unit.
- 3、 During long periods of non-use, disconnect the unit's main power.
- 4、 It should be installed in a well-ventilated place, at a distance of 50 centimeters or more with the walls. At the same time, please check if the fan and ventilation holes are unobstructed

Statement

The product has perfect performance and integrity packing. All users should be strictly comply with the warning and operating instructions as stated. Or we aren't in charge of any result by misusing. Any damage resulting by misuse is not within the Company's warranty. Any fault or problem caused by neglecting the manual is also not in the charge of dealers.

Note: All information is subject to change without prior notice.

Safety Precautions

- 1、 In order to guarantee the product's life, please don't put it in the damp places or even the environment over 60degrees.
- 2、 Always mount this unit in safe and stable matter.
The qualified professionals are allowed to carry out the lamp installation, operation and maintenance, but they must guarantee to operate in strict accordance with the instructions referred to.
- 3、 Using lamp, the change rate of Power voltage should be within $\pm 10\%$, If the voltage is too high, it will shorten the light's life; if it's not enough, the lamp will be dark.
- 4、 Please restart it after turning off light for 20 minutes until full-cooling. Frequent switching will reduce the life span of lamps and bulbs; intermittent using will improve the life of bulbs and lamps.
- 5、 In order to make sure the product is used well, please read the Manual carefully.

Products Instruction

- Lamp: Lamp 700W
- Channel Model: 13 chs ,DMX512
- Pan scan: 540°(16bit) Electric correction
- Tilt scan: 270° (16bit) Electric correction
- Color Wheel: 8 Color+White, Single rotation rainbow effect, two models changing (Full color and half color operating) from tai wan color.
- Gobos: 8gobos +white, Double rotation rainbow effect
- Strobe: 13 t/s, free strobe and fuse strobe
- Frog: 0%~100% linear frog,
- Nice red spot and full display
- Self developed switch power: lighter, stable, self protect
- Controller can open the light and reset, including delaying function

Voltage: AC210~240V, 50/60HZ

Light dimension: 396X390X630

Carton packing: 515X440X785

Flightcase:470X470X785(Single) 470X920X785(Double)

Net: 21kgs

Gross: 24kgs

Menu Function:

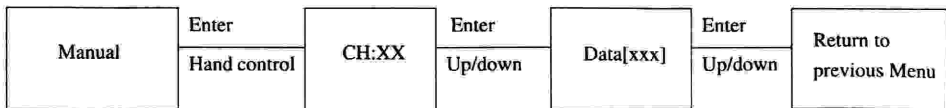
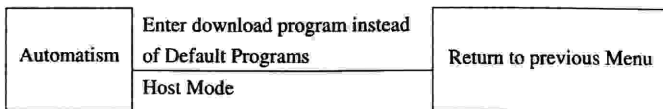
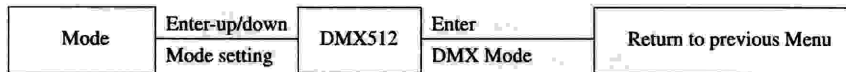
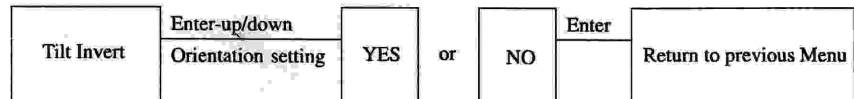
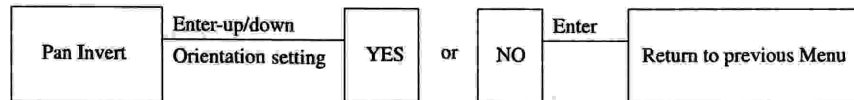
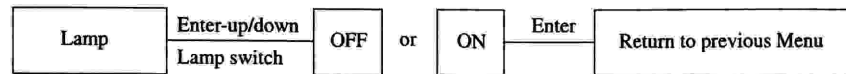
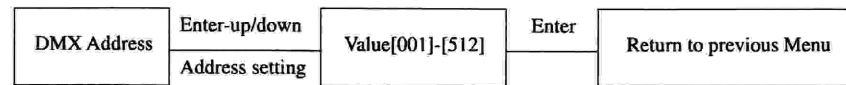

Channels Control:

Channel	DMX	Control
1CH Dimming	0-255	From dark to bright
2CH Strobe	0-250	Slow to fast strobe
	250-255	blank
3CH Color Wheel Mode	0-127	Mode 1
	128-255	Mode 2
4CH XY Speed Adjustment	0-255	Slow to fast
5CH X	0-255	Rotating 0-540
6CH Y	0-255	Rotating 0-270
7CH Color Wheel	0-13	White
	14-27	Color 1
	28-41	Color 2
	42-55	Color 3
	56-69	Color 4
	70-83	Color 5
	84-97	Color 6
	98-111	Color 7
	112-127	Color 8
	128-255	water effect slow to fast
8CH Gobo Wheel	0-6	white
	7--13	Gobo 1
	14-20	Gobo 2
	21-27	Gobo 3
	28-35	Gobo 4
	36-41	Gobo 5
	42-48	Gobo 6
	49-55	Gobo 7
	56-63	Gobo 8
	64-77	Gobo 8 swing
	78-91	Gobo 7 swing
	92-105	Gobo 6 swing
	106-119	Gobo 5 swing
	120-133	Gobo 4 swing
	134-147	Gobo 3 swing
	148-161	Gobo 2 swing
	163-175	Gobo 1 swing
176-191	White	

	192-255	water effect slow to fast
9CH Prism	0-127	Prism On
	128-255	Prism Off
10CH Prism Self-rotation	0-255	slow to fast
11CH Reset	0-250	Blank
	251-255	Reset after 3 seconds
12CH X fine	0-255	X 16BIT
13CH Y fine	0-255	Y 16BIT

